

CATALOGUS

STEIGER

MS-1



MEGASTEIGER

BRENGT U VEILIG HOGEROP

BELGIE 0494/69.84.87 NEDERLAND 06/38018487

STOPHOUT



Lengte 110cm

Breedte 20cm

Dikte 40mm



Lengte 110cm

Breedte 25cm

Dikte 50mm



VOETSPINDEL



| MODEL | 40 | 50 | 60 | 80 | 100 | 60K |
|------------------|---------|---------|---------|---------|---------|---------|
| LENGTE | 400mm | 500mm | 600mm | 800mm | 1000mm | 600mm |
| MAX REGEL HOOGTE | 250mm | 350mm | 450mm | 600mm | 750mm | 450mm |
| VOETPLAAT | 150X150 | 150X150 | 150X150 | 150X150 | 150X150 | 150X150 |
| GEWICHT | 2,8KG | 3,1KG | 3,5KG | 4,1KG | 4,8KG | 4,4KG |
| MATERIAAL | GALVA | GALVA | GALVA | GALVA | GALVA | GALVA |

STALEN

FRAMES 73

Technische gegevens

Diameter buizen 48,3mm

Wanddikte 2,7mm

Staalsoort S235

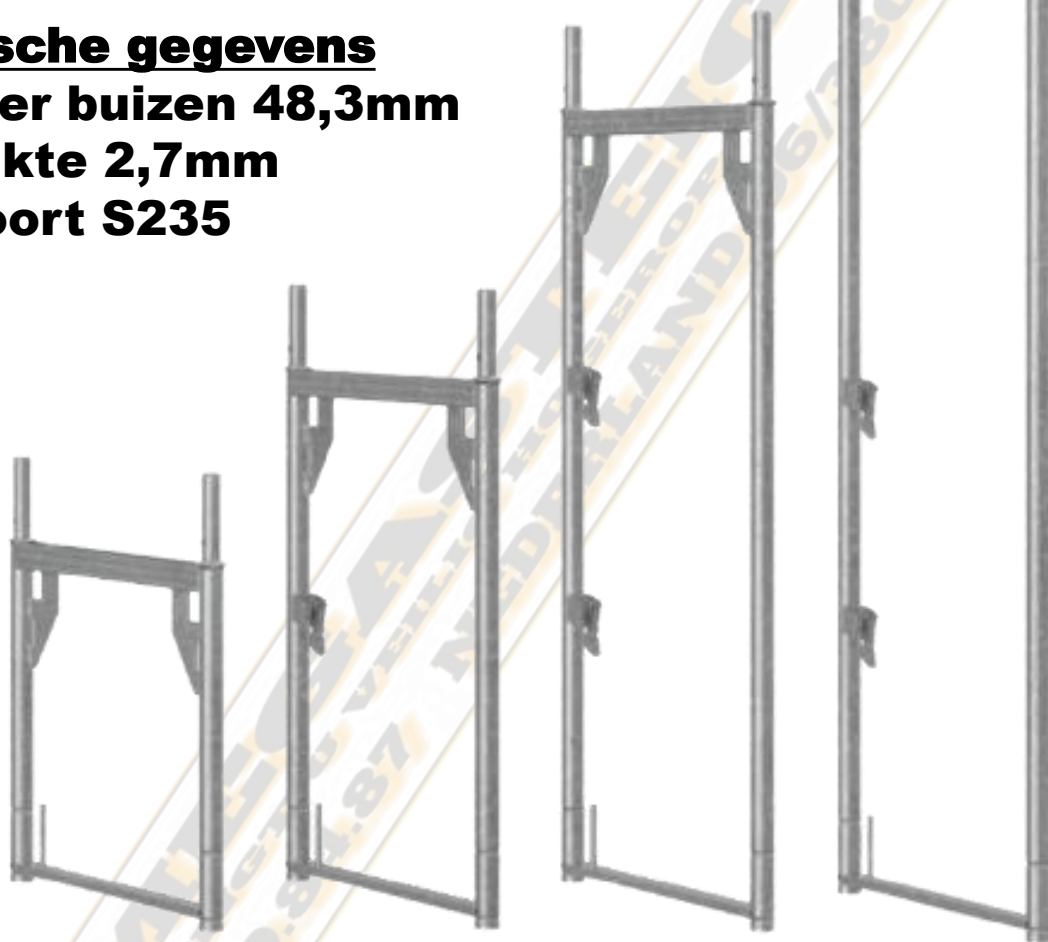

| MODEL | 66/73 | 100/73 | 150/73 | 200/73 |
|-------------|--------|--------|--------|--------|
| HOOGTE | 660mm | 1000mm | 1500mm | 2000mm |
| BREEDTE HOH | 732mm | 732mm | 732mm | 732mm |
| HOOGTE TOT | 826mm | 1160mm | 1660mm | 2160mm |
| BREEDTE TOT | 780mm | 780mm | 780mm | 780mm |
| GEWICHT | 10,5KG | 12,6KG | 16,2KG | 19,2KG |
| MATERIAAL | GALVA | GALVA | GALVA | GALVA |

Frame met leuning aan beide zijden



| MODEL | 200/73 4K |
|-------------|-----------|
| HOOGTE | 2000mm |
| BREEDTE HOH | 732mm |
| HOOGTE TOT | 2160mm |
| BREEDTE TOT | 780mm |
| GEWICHT | 19,9KG |
| MATERIAAL | GALVA |

Doorloopframe / voetgangersframe

| MODEL | 220/150 |
|-------------|---------|
| HOOGTE | 2200mm |
| BREEDTE HOH | 1500mm |
| HOOGTE TOT | 2360mm |
| BREEDTE TOT | 1548mm |
| GEWICHT | 34,40KG |
| MATERIAAL | GALVA |



Borstweringsframe



Frame 36cm

| MODEL | Borstwering 200/73 |
|-------------|--------------------|
| HOOGTE | 2000mm |
| BREEDTE HOH | 732mm |
| HOOGTE TOT | 2160mm |
| BREEDTE TOT | 780mm |
| GEWICHT | 23,9KG |
| MATERIAAL | GALVA |

| MODEL | 200/36 |
|-------------|--------|
| HOOGTE | 2000mm |
| BREEDTE HOH | 362mm |
| HOOGTE TOT | 2160mm |
| BREEDTE TOT | 410mm |
| GEWICHT | 19,3KG |
| MATERIAAL | GALVA |



STALEN

FRAMES 109

Technische gegevens

Diameter buizen 48,3mm

Wanddikte 2,7mm

Staalsoort S235



| MODEL | 66/109 | 100/109 | 150/109 | 200/109 |
|-------------|--------|---------|---------|---------|
| HOOGTE | 660mm | 1000mm | 1500mm | 2000mm |
| BREEDTE HOH | 1088mm | 1088mm | 1088mm | 1088mm |
| HOOGTE TOT | 826mm | 1160mm | 1660mm | 2160mm |
| BREEDTE TOT | 1136mm | 1136mm | 1136mm | 1136mm |
| GEWICHT | 12,7KG | 15,2KG | 19,9KG | 23,6KG |
| MATERIAAL | GALVA | GALVA | GALVA | GALVA |

ALUMINIUM FRAMES 73



Technische gegevens

Diameter buizen 48,3mm

Wanddikte 4,0 mm

Volledig aluminium

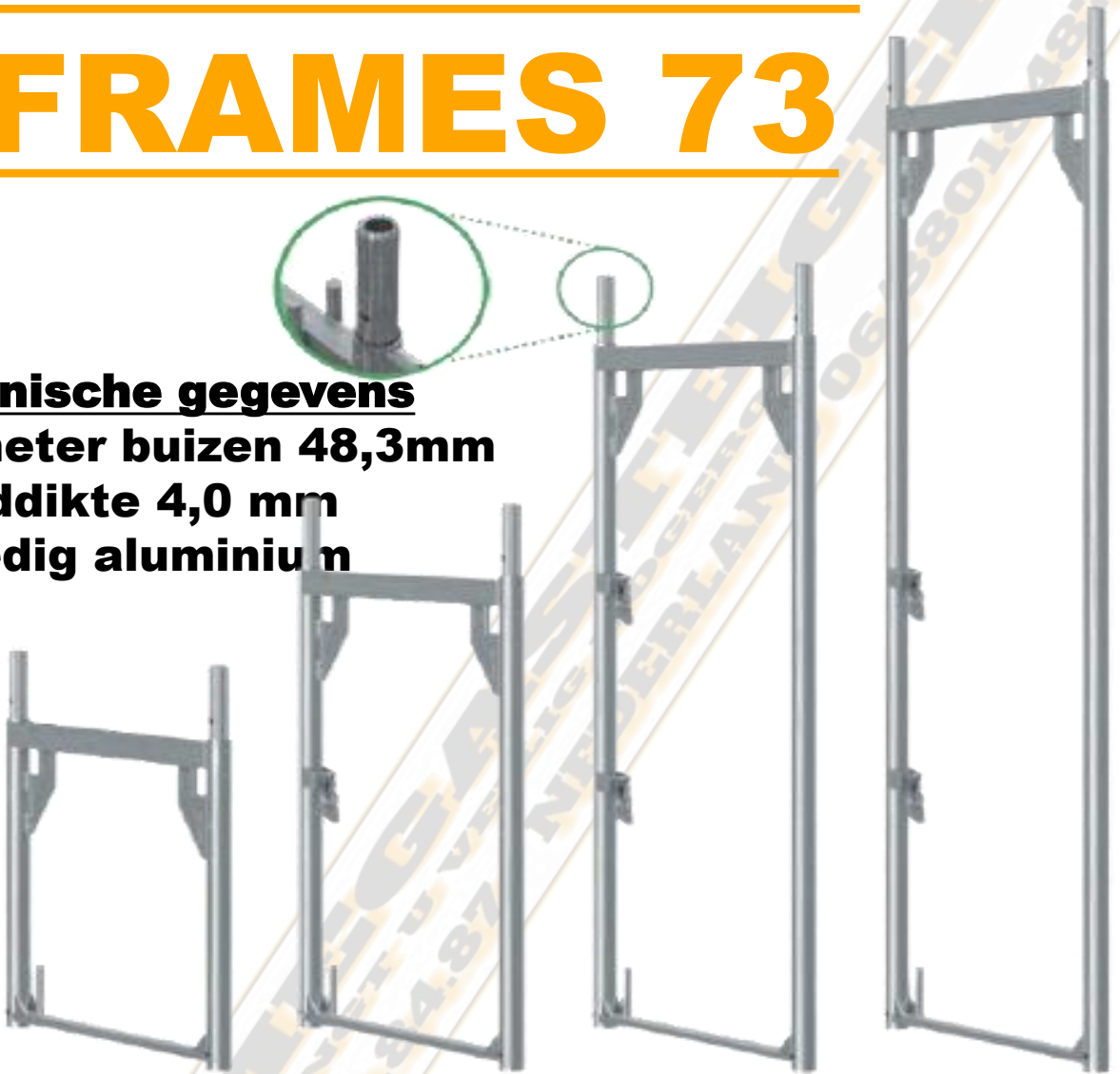

| MODEL | 66/73 | 100/73 | 150/73 | 200/73 |
|-------------|-----------|-----------|-----------|-----------|
| HOOGTE | 666mm | 1000mm | 1500mm | 2000mm |
| BREEDTE HOH | 732mm | 732mm | 732mm | 732mm |
| HOOGTE TOT | 821mm | 1155mm | 1655mm | 2155mm |
| BREEDTE TOT | 780mm | 780mm | 780mm | 780mm |
| GEWICHT | 4,5KG | 5,6KG | 7,2KG | 8,8KG |
| MATERIAAL | ALUMINIUM | ALUMINIUM | ALUMINIUM | ALUMINIUM |

STALEN VLONDERS

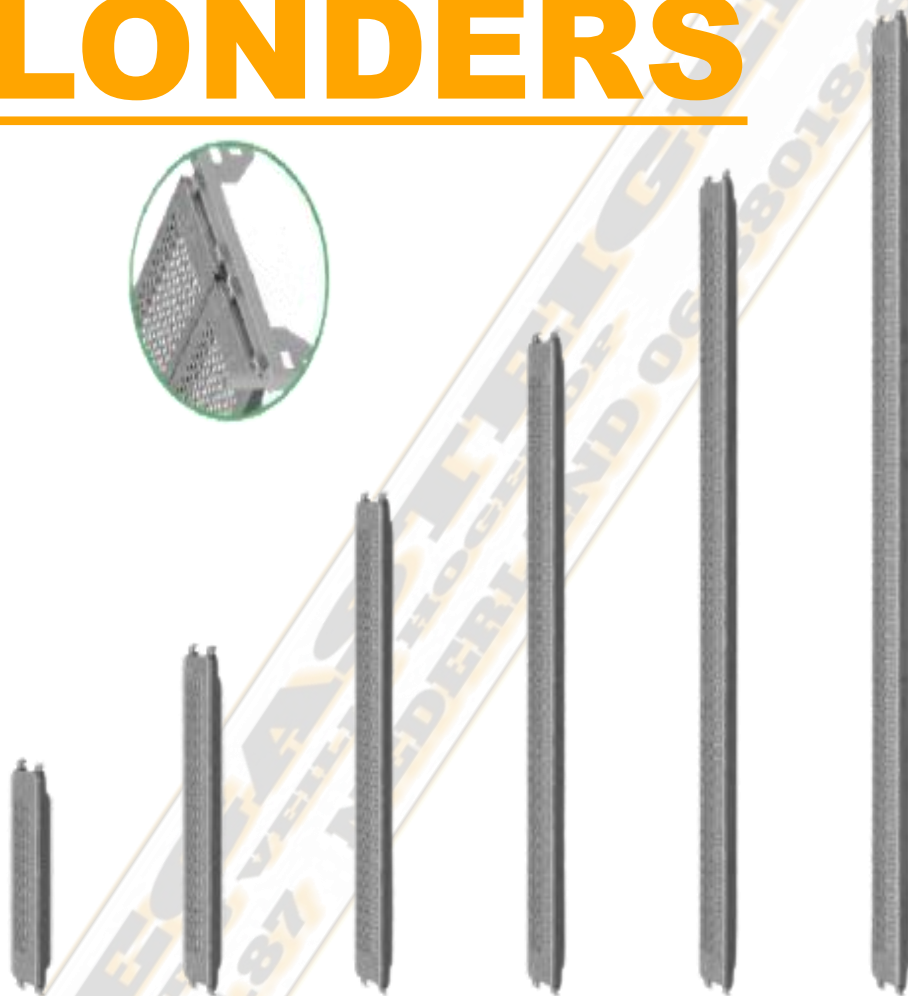

| MODEL | 73 | 109 | 157 | 207 | 257 | 307 |
|----------------|--------------------|--------------------|--------------------|--------------------|--------------------|--------------------|
| LENGTE SYSTEEM | 732mm | 1088mm | 1572mm | 2072mm | 2572mm | 3072mm |
| BREEDTE | 320mm | 320mm | 320mm | 320mm | 320mm | 320mm |
| LENGTE TOTAAL | 722mm | 1078mm | 1562mm | 2062mm | 2562mm | 3062mm |
| GEWICHT | 5,7KG | 7,6KG | 10,2KG | 13,5KG | 16,3KG | 19,1KG |
| KLASSE | 6 | 6 | 6 | 6 | 5 | 4 |
| BELASTING | 6KN/m ² | 6KN/m ² | 6KN/m ² | 6KN/m ² | 5KN/m ² | 4KN/m ² |
| MATERIAAL | GALVA | GALVA | GALVA | GALVA | GALVA | GALVA |

ROBUUST VLONDERS



| 307L | 307 | 257L | 257 | 207L | 207 | 157L | 157 | MODEL |
|-----------------------|-------|-------|-------|-------|-------|-------|-------|----------|
| 3072 | 3072 | 2572 | 2572 | 2072 | 2072 | 1572 | 1572 | LENGTE |
| 3062 | 3062 | 2562 | 2562 | 2062 | 2062 | 1562 | 1562 | LENGTE T |
| 605 | 605 | 605 | 605 | 605 | 605 | 605 | 605 | BREEDTE |
| 25,3K | 21,2K | 19,8K | 17,9K | 15,9K | 14,8K | 12,6K | 11,5K | GEWICHT |
| ALUMINIUM / MULTIPLEX | | | | | | | | MATERIA |
| 3 | 3 | 3 | 3 | 3 | 3 | 3 | 3 | KLASSE |
| JA | NEE | JA | NEE | JA | NEE | JA | NEE | LUIK |
| JA | NEE | JA | NEE | NEE | NEE | NEE | NEE | LADDER |

STEIGER LADDER

**WORD
GEBRUIKT IN
VLONDERS
MET LUIK DIE
TE KORT ZIJN
OM EEN
LADDER IN TE
WERKEN**

**MAAR OOK BIJ
MOEILIJK
BEREIKBARE
PLAATSEN**

| MODEL | LAD200 |
|---------|--------|
| BREEDTE | 340 |
| LENGTE | 2120 |
| GEWICHT | 7,5KG |

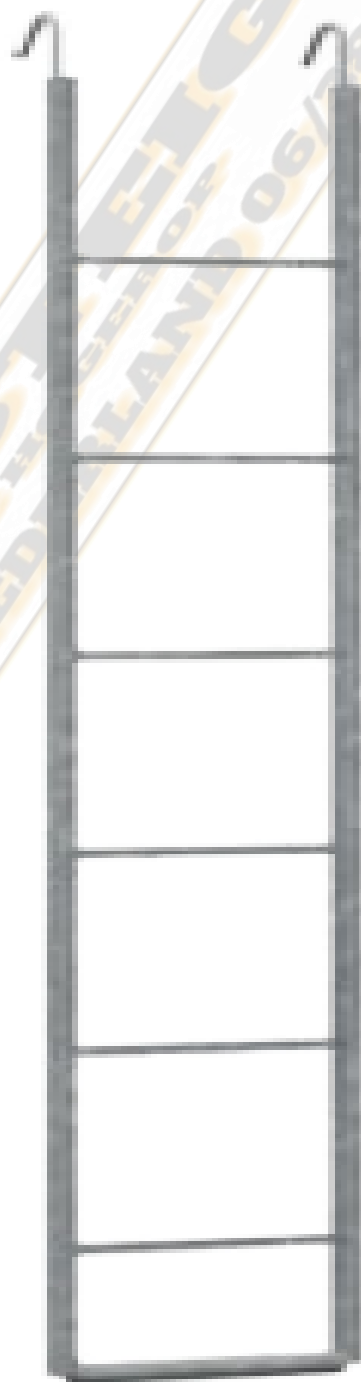

ALUMINIUM VLONDERS



| 307L | 307 | 257L | 257 | MODEL |
|-----------|-------|-------|-------|---------------|
| 3072 | 3072 | 2572 | 2572 | LENGTE |
| 3062 | 3062 | 2562 | 2562 | LENGTE TOTAAL |
| 605 | 605 | 605 | 605 | BREEDTE |
| 21,4K | 17,2K | 18,8K | 14,6K | GEWICHT |
| ALUMINIUM | | | | MATERIAAL |
| 3 | 3 | 3 | 3 | KLASSE |
| JA | NEE | JA | NEE | LUIK |
| JA | NEE | JA | NEE | LADDER |

DIAGONALEN



| 73 | 109 | 157 | 207 | 257 | 307 | MODEL |
|--------|-------|-------|-------|-------|-------|-----------|
| 1834 | 2018 | 2430 | 2830 | 3222 | 3643 | LENGTE |
| 5,0KG | 5,4KG | 6,6KG | 6,7KG | 7,5KG | 8,4KG | GEWICHT |
| 42,4mm | | | | | | DIAMETER |
| GALVA | | | | | | MATERIAAL |

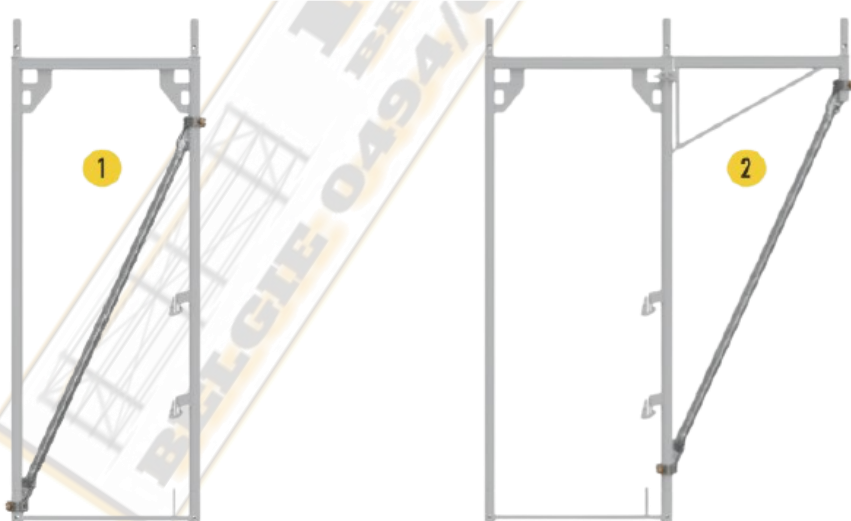

DIAGONAAL 73 EN 109
WORDEN OOK GEBRUIKT
IN DE FRAMES (1) EN TER
ONDERSTEUNING VAN
CONSOLES (2)

ENKELE LEUNING STAAL



| 73 | 109 | 157 | 207 | 257 | 307 | MODEL |
|-------|-------|-------|-------|-------|-------|------------|
| 732 | 1088 | 1572 | 2072 | 2572 | 3072 | LENGTE |
| 765 | 1121 | 1605 | 2105 | 2605 | 3105 | LENGTE TOT |
| 1,5KG | 2,0KG | 3,0KG | 3,8KG | 4,7KG | 5,4KG | GEWICHT |
| 38mm | | | | | | DIAMETER |
| GALVA | | | | | | MATERIAAL |

DUBBELE LEUNING STAAL OF ALU

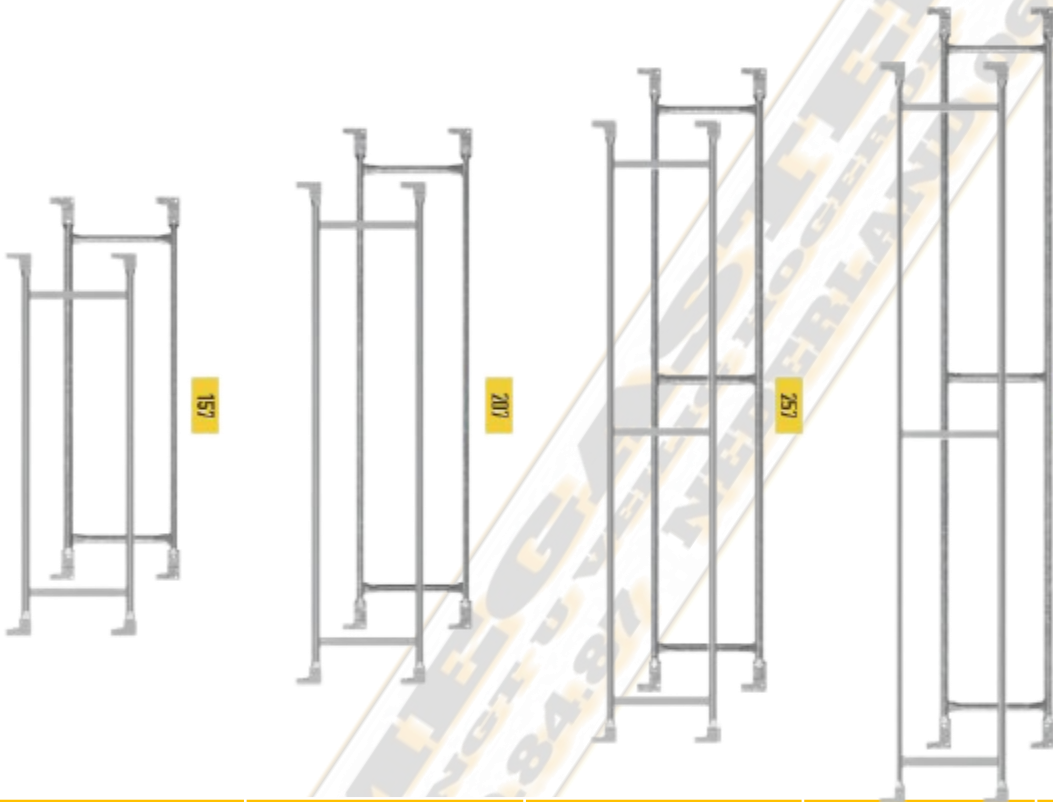

| 157 | 207 | 257 | 307 | MODEL |
|--------------------|-------|--------|--------|---------------|
| 1572 | 2072 | 2572 | 3072 | LENGTE |
| 1605 | 2105 | 2605 | 3105 | LENGTE TOT |
| 545mm | | | | HOOGTE |
| 7,2KG | 8,9KG | 11,4KG | 13,1KG | GEWICHT STAAL |
| 2,8KG | 3,4KG | 4,3KG | 4,9KG | GEWICHT ALU |
| 38,3 mm | | | | DIAMETER |
| STAAL OF ALUMINIUM | | | | MATERIAAL |

Alle afmetingen in mm

KOPSE LEUNINGEN

DUBBELE KOPSE LEUNING

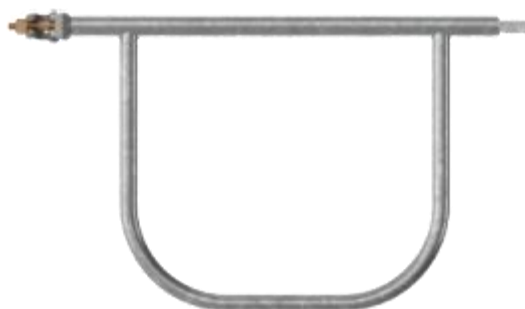

| MODEL | DUBBEL 73 | DUBBEL 109 |
|-------------|-------------|------------|
| BREEDTE | 732 | 1088 |
| BREEDTE TOT | 760 | 1116 |
| HOOGTE | 500 | 500 |
| GEWICHT | 3,2KG | 4,4KG |
| MATERIAAL | STAAL GALVA | |

ENKELE KOPSE LEUNING



| MODEL | ENKEL 73 | ENKEL 109 |
|-------------|-------------|-----------|
| BREEDTE | 732 | 1088 |
| BREEDTE TOT | 760 | 1116 |
| HOOGTE | 40 | 40 |
| GEWICHT | 1,9KG | 2,6KG |
| MATERIAAL | STAAL GALVA | |

KANTPLANKEN

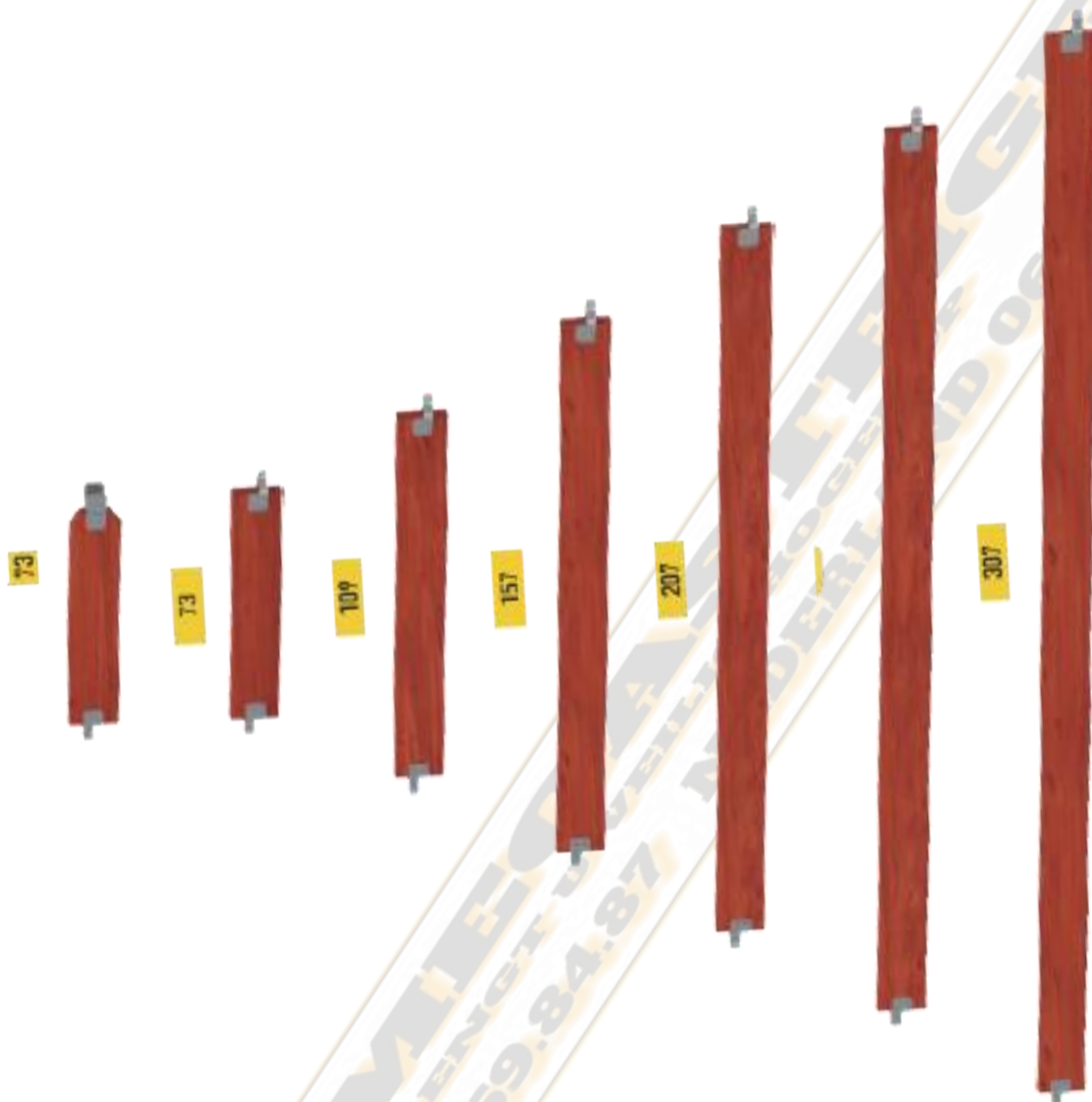

| KOPS | 73 | 109 | 157 | 207 | 257 | 307 | MODEL |
|-----------------------------|-------|-------|-------|-------|-------|-------|------------|
| 732 | 732 | 1088 | 1572 | 2072 | 2572 | 3070 | LENGTE TOT |
| 710 | 710 | 1105 | 1590 | 2090 | 2590 | 3090 | LENGTE |
| 150 | | | | | | | HOOGTE |
| 1,3KG | 1,6KG | 2,4KG | 3,2KG | 4,1KG | 5,1KG | 6,1KG | GEWICHT |
| HOUT GEDRENKT / STAAL GALVA | | | | | | | MATERIAAL |

KANTPLANKEN MET UW LOGO

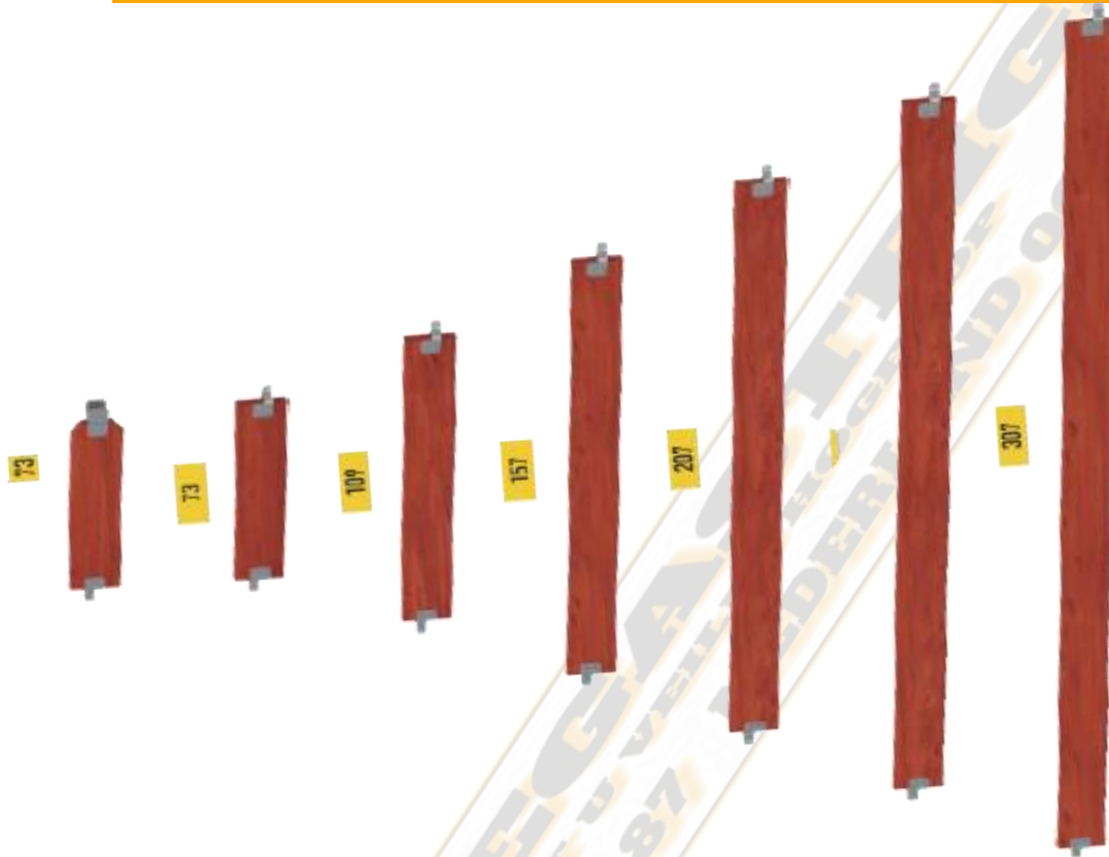

| KOPS | 73 | 109 | 157 | 207 | 257 | 307 | MODEL |
|-----------------------------|-------|-------|-------|-------|-------|-------|------------|
| 732 | 732 | 1088 | 1572 | 2072 | 2572 | 3070 | LENGTE TOT |
| 710 | 710 | 1105 | 1590 | 2090 | 2590 | 3090 | LENGTE |
| 150 | | | | | | | HOOGTE |
| 1,3KG | 1,6KG | 2,4KG | 3,2KG | 4,1KG | 5,1KG | 6,1KG | GEWICHT |
| HOUT GEDRENKT / STAAL GALVA | | | | | | | MATERIAAL |

*****VANAF 50 STUKS *****
BLAUWE ACHTERGROND IPV ROOD
TEKST / LOGO WIT

Alle afmetingen in mm

LEUNINGSTIJL

‘L’

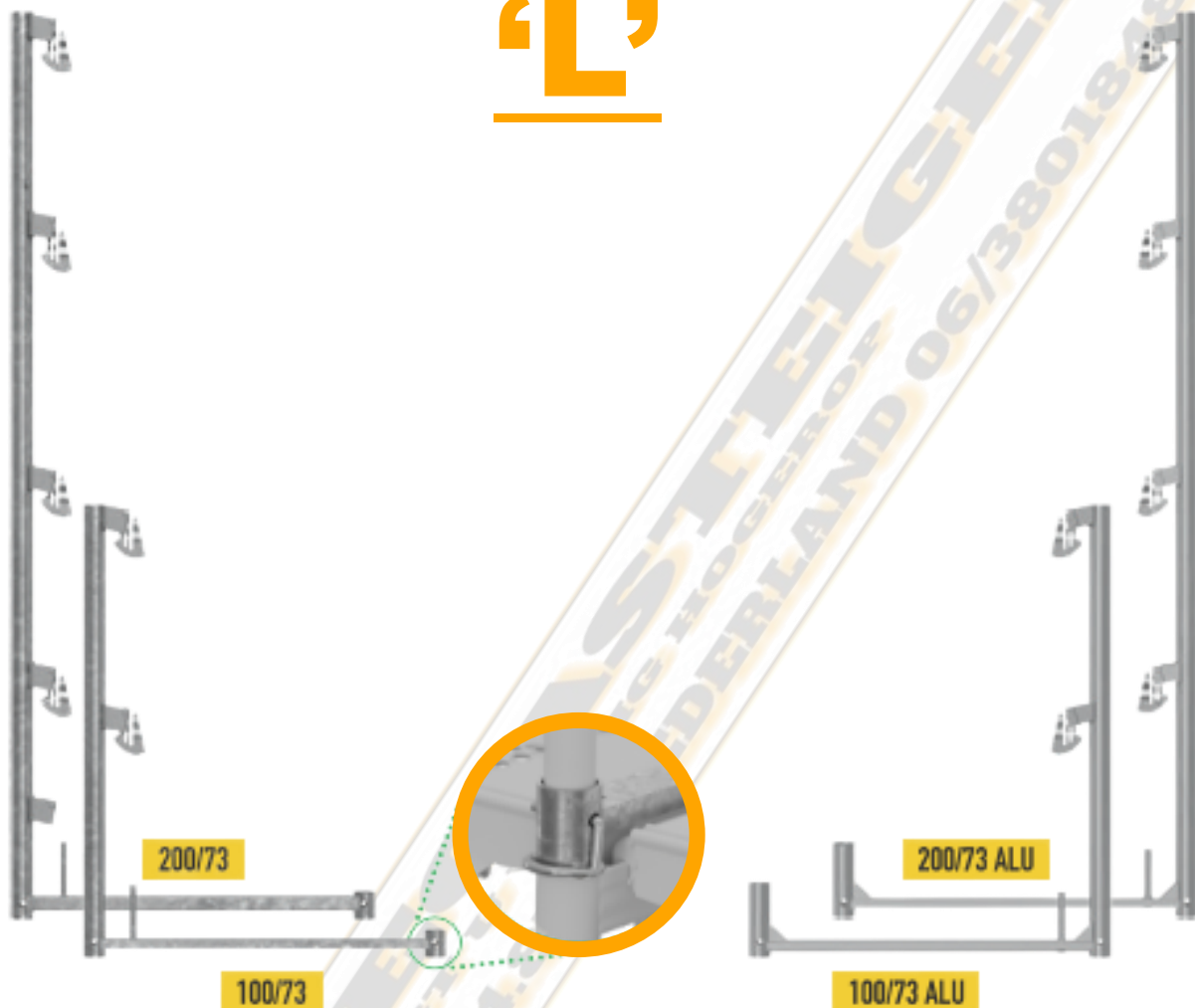

| MODEL | 100/73 | 200/73 | 100/109 | 200/109 | 100/73A | 200/73A |
|-------------|--------|--------|---------|---------|---------|---------|
| HOOGTE | 1000 | 2000 | 1000 | 2000 | 1000 | 2000 |
| BREEDTE | 732 | 732 | 1088 | 1088 | 732 | 732 |
| HOOGTE TOT | 1000 | 2000 | 1000 | 2000 | 1000 | 2000 |
| BREEDTE TOT | 780 | 780 | 1136 | 1136 | 780 | 780 |
| GEWICHT | 5,5KG | 12,8KG | 6,4KG | 14,0KG | 2,3KG | 3,8KG |
| MATERIAAL | GALVA | GALVA | GALVA | GALVA | ALU | ALU |

LEUNINGSTIJL

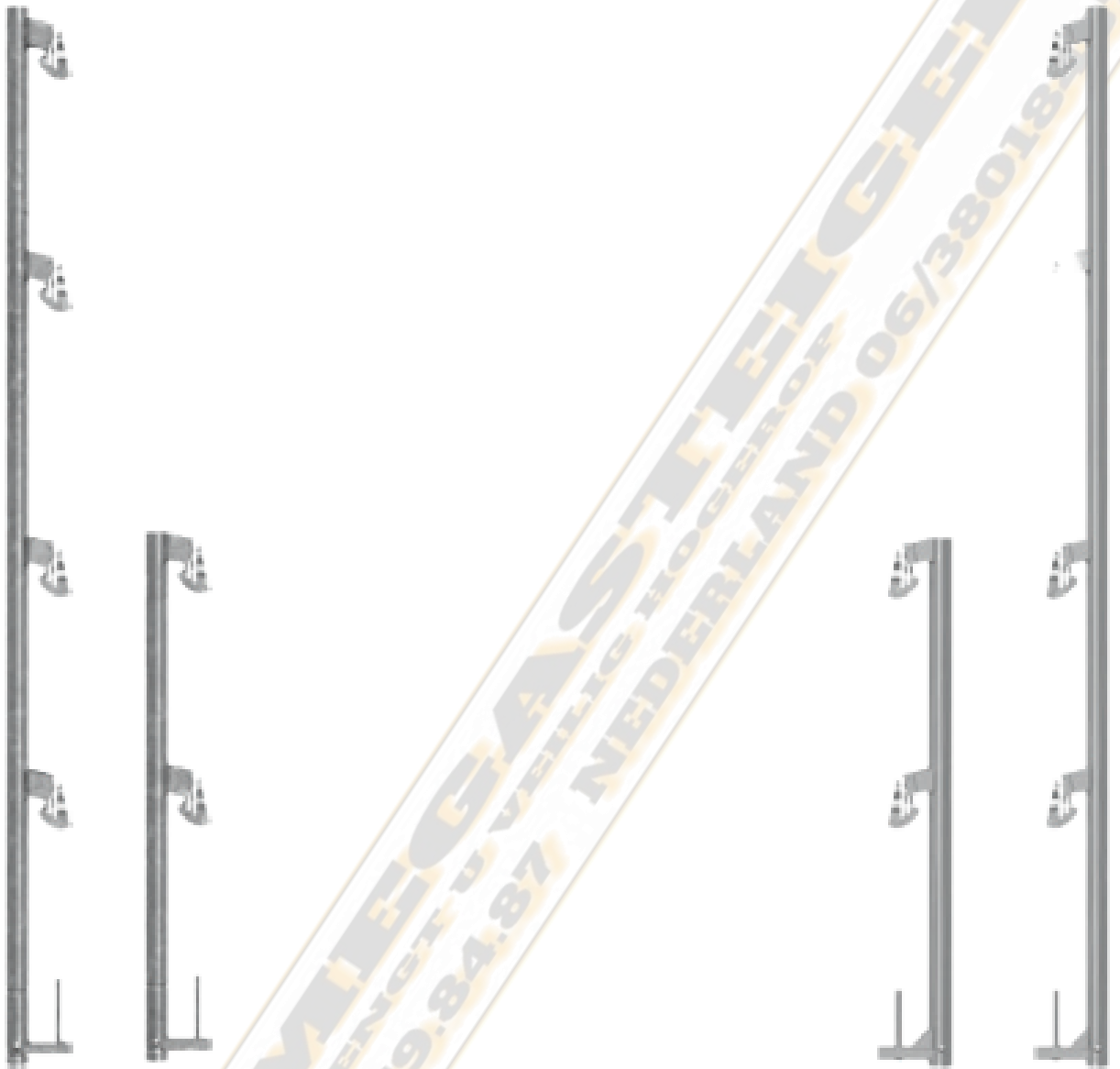

| MODEL | 100 | 200 | 100ALU | 200ALU |
|--------------|-------|-------|--------|--------|
| HOOGTE | 1000 | 2000 | 1000 | 2000 |
| BREEDTE VOET | 135 | 135 | 150 | 150 |
| HOOGTE TOT | 1000 | 2000 | 1000 | 2000 |
| GEWICHT | 4,3KG | 8,7KG | 2,0KG | 3,2KG |
| MATERIAAL | GALVA | GALVA | ALU | ALU |

LEUNINGSTIJL CONSOLE

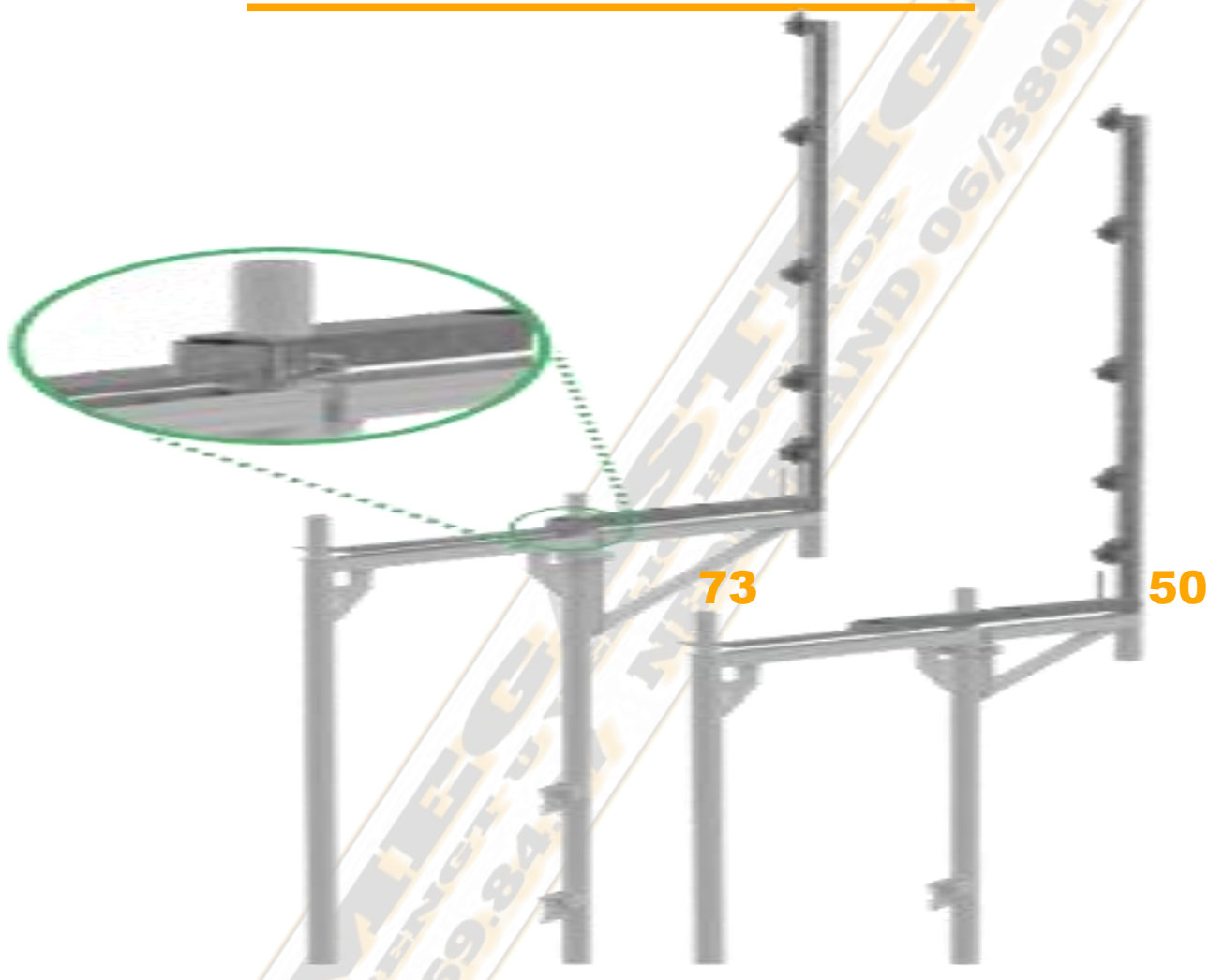

| MODEL | 200 |
|----------------|-----------------|
| HOOGTE | 2000 |
| BREEDTE VOET | 732 / 500 / 356 |
| BREEDTE TOTAAL | 798 |
| GEWICHT | 13,2KG |
| MATERIAAL | GALVA |

EIND LEUNINGSTIJL

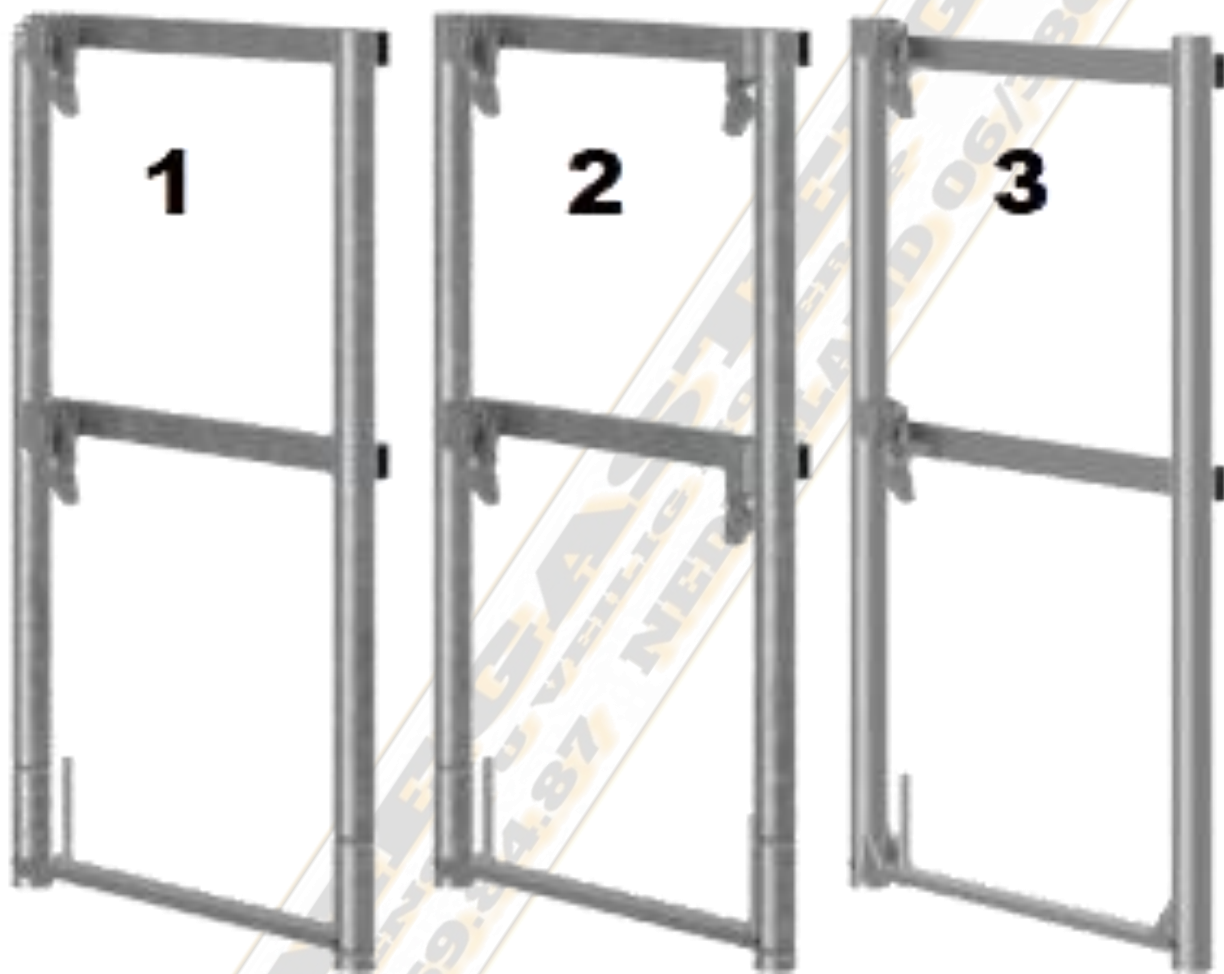

| MODEL | 73 (1) | 73 4K (2) | 109 (1) | 109 4K (2) | 73 ALU (3) |
|-------------|--------|-----------|---------|------------|------------|
| HOOGTE | 1000 | 1000 | 1000 | 1000 | 1000 |
| BREEDTE | 732 | 732 | 1088 | 1088 | 732 |
| BREEDTE TOT | 780 | 780 | 1136 | 1136 | 780 |
| GEWICHT | 10,8KG | 11,5KG | 13,4KG | 14,1KG | 4,4KG |
| MATERIAAL | GALVA | GALVA | GALVA | GALVA | ALU |

CONSOLES

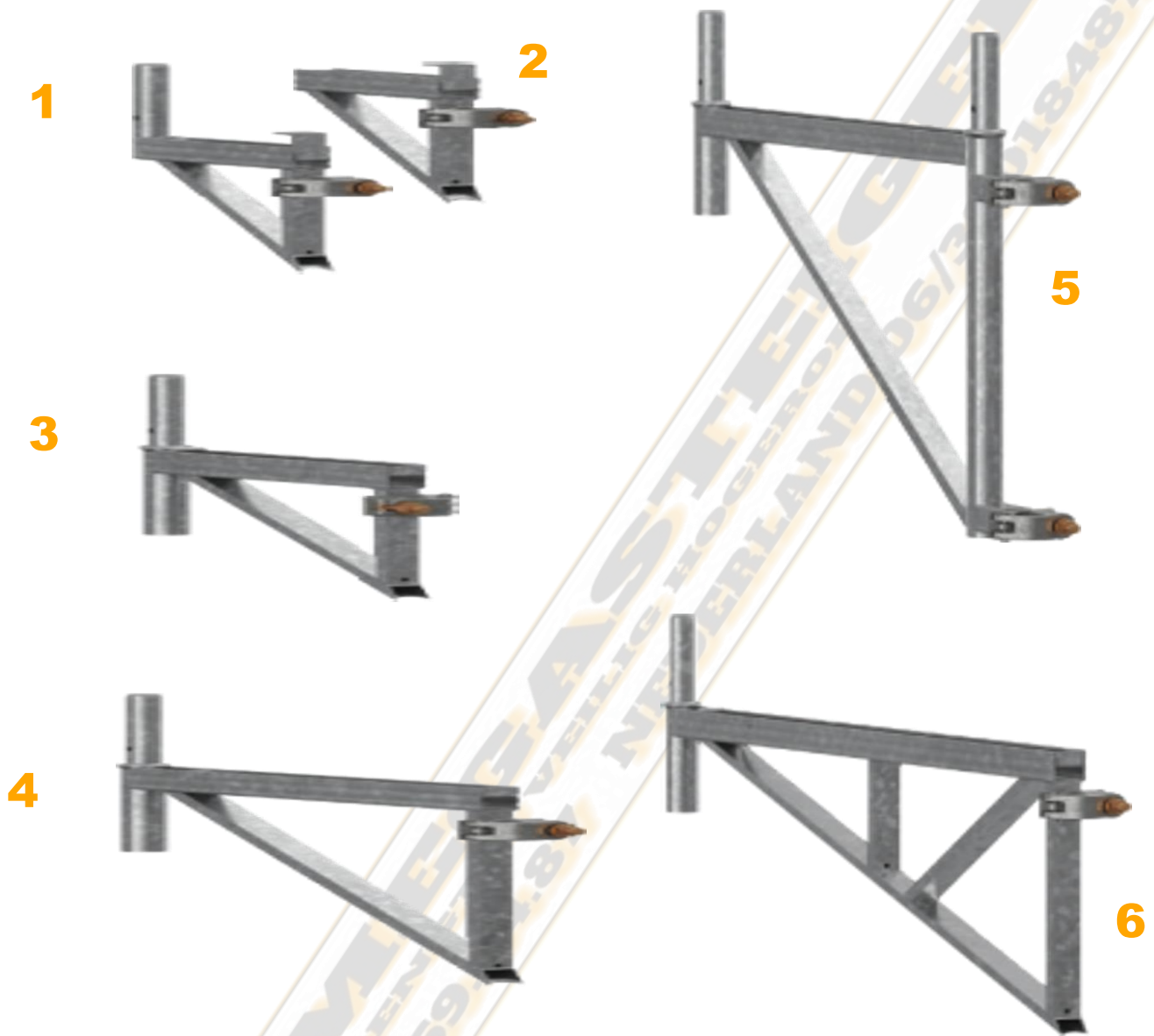

| MODEL | 36 P (1) | 36 (2) | 50 P (3) | 73 P (4) | 73 2P (5) | 109 P (6) |
|-------------|----------|--------|----------|----------|-----------|-----------|
| HOOGTE | 310 | 450 | 455 | 585 | 825 | 635 |
| BREEDTE | 356 | 356 | 500 | 732 | 732 | 1088 |
| BREEDTE TOT | 390 | 440 | 580 | 815 | 930 | 1170 |
| GEWICHT | 2,7KG | 3,3KG | 4,8KG | 6,3KG | 9,4KG | 9,2KG |
| MATERIAAL | GALVA | GALVA | GALVA | GALVA | GALVA | GALVA |

TUSSEN LIGGERS

STARTLIGGER / TRAPLIGGER ONDERAAN

WORD GEBRUIKT OM TRAPPEN ONDERAAN TE BEGINNEN
PLAATSSEN OF ONDERAAN EEN VLOER TE VOORZIEN



SL

TUSSENLIGGER

WORD IN DE FRAMES GEMONTEERD OM ZO DE WERKVLOER
OP VERSCHILLENDE HOOGTES TE KUNNEN PLAATSSEN



TL

| MODEL | SL73 | SL109 | TL73 | TL109 |
|------------|-------|-------|-------|-------|
| HOOGTE | 65 | 65 | 52 | 52 |
| LENGTE | 732 | 1088 | 732 | 1088 |
| LENGTE TOT | 780 | 1136 | 813 | 1139 |
| GEWICHT | 2,8KG | 4,1KG | 3,4KG | 4,7KG |
| MATERIAAL | GALVA | GALVA | GALVA | GALVA |

TRALIELIGGERS

STAAL

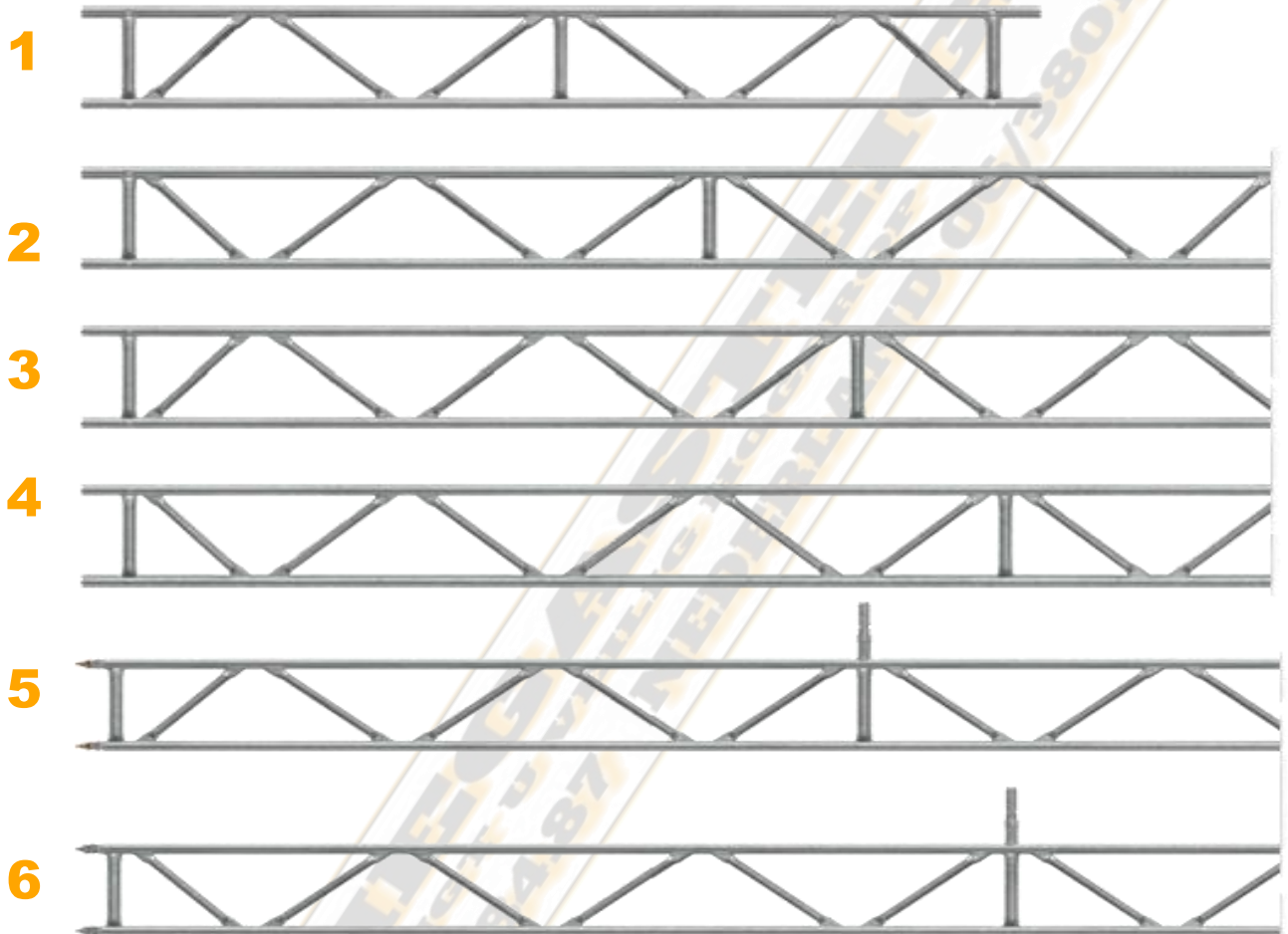

| MODEL | 324 | 424 | 524 | 514P | 624 | 614P |
|------------|--------|--------|--------|--------|--------|--------|
| NR FOTO | 1 | 2 | 3 | 5 | 4 | 6 |
| LENGTE | 3240 | 4240 | 5240 | 5140 | 6240 | 6140 |
| HOOGTE | 400 | 400 | 400 | 400 | 400 | 400 |
| HOOGTE TOT | 448 | 448 | 448 | 720 | 448 | 720 |
| GEWICHT | 33,0KG | 42,1KG | 51,2KG | 52,8KG | 60,3KG | 61,8KG |
| MATERIAAL | GALVA | GALVA | GALVA | GALVA | GALVA | GALVA |

Alle afmetingen in mm

TRALIELIGGERS

ALUMINIUM

1



2



3



4



5



| MODEL | 324 | 424 | 524 | 624 | 824 |
|------------|--------|--------|--------|--------|--------|
| NR FOTO | 1 | 2 | 3 | 4 | 5 |
| LENGTE | 3240 | 4240 | 5240 | 6240 | 8240 |
| HOOGTE | 400 | 400 | 400 | 400 | 400 |
| HOOGTE TOT | 448 | 448 | 448 | 448 | 448 |
| GEWICHT | 12,8KG | 16,5KG | 20,1KG | 23,8KG | 31,3KG |
| MATERIAAL | ALU | ALU | ALU | ALU | ALU |

TOEBEHOREN TRALIELIGGERS



| MODEL | CONNECTOR BUIS | CONNECTOR VLOER |
|----------------|----------------|-----------------|
| NUMMER OP FOTO | 1 | 2 |
| LENGTE | 415 | 732 |
| HOOGTE | 38 | 60 |
| GEWICHT | 2,3KG | 2,8KG |
| MATERIAAL | GALVA | GALVA |

STEIGERBUIS



DIAMETER 48,3mm
STAALSOORT S235
BESCHIKBAAR IN

- **WANDDIKTE 2,7mm**
- **WANDDIKTE 3,2mm**

| MODEL | 100 | 200 | 300 | 400 | 500 | 600 |
|-------------------|-------|-------|--------|--------|--------|--------|
| LENGTE | 1000 | 2000 | 3000 | 4000 | 5000 | 6000 |
| GEWICHT 2,7 MM | 3,1KG | 6,3KG | 9,5KG | 12,7KG | 15,9KG | 19,1KG |
| GEWICHT 3,2mm | 3,7KG | 7,4KG | 11,2KG | 14,9KG | 18,6KG | 22,4KG |
| MATERIAAL | GALVA | GALVA | GALVA | GALVA | GALVA | GALVA |

KOPPELINGEN

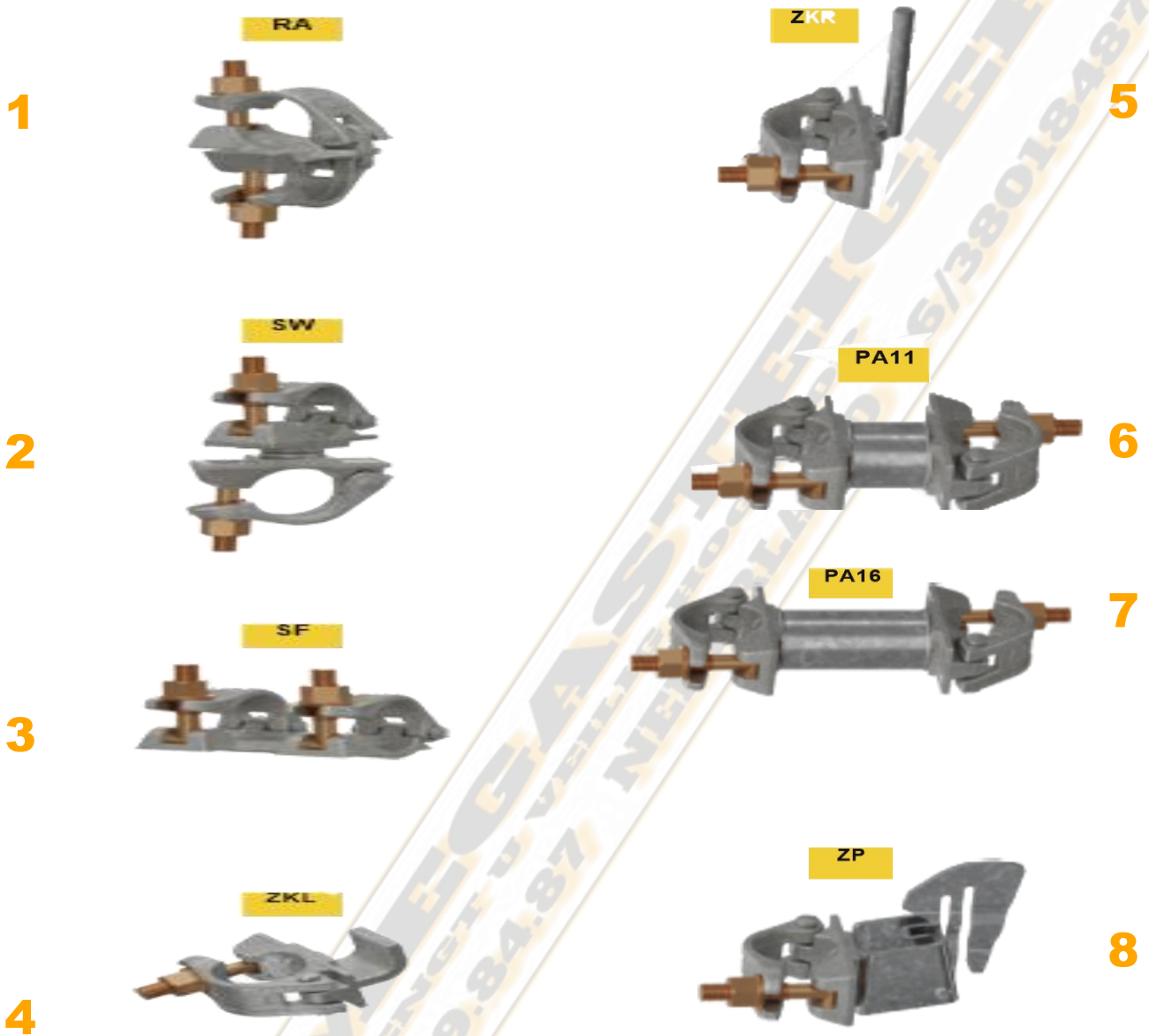

| MODEL | RA | SW | SF | ZKL | ZKR | PA11 | PA16 | ZP |
|-----------|-------|--------|-------|-------|-------|-------|-------|-------|
| NR FOTO | 1 | 2 | 3 | 4 | 5 | 6 | 7 | 8 |
| GEWICHT | 1,1KG | 1,25KG | 1,5KG | 0,8KG | 0,8KG | 1,4KG | 1,6KG | 1,1KG |
| MATERIAAL | GALVA | GALVA | GALVA | GALVA | GALVA | GALVA | GALVA | GALVA |

TOEBEHOREN

**STEIGER
RATELSLEUTEL 19/22**



**KOPPELSTUK VOOR
STEIGERBUIS**



**STEIGERNETTEN 2,5 OF
3M BREED ROL 10 OF
20M**



**VERVANGBOUT
VOOR KOPPELINGEN**



**DAKDEKKERSNETTEN
GAASOPENING 4,5X
4,5CM / 8CM X 8CM /
10CM X 10CM**

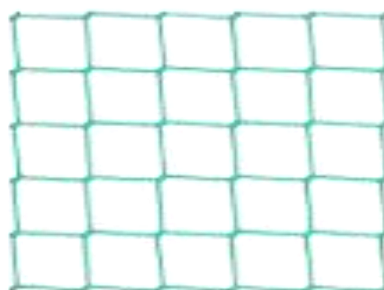

**BORGPEN VOOR KADERS
EN LEUNINGSTIJL**



STEIGER TRAPPEN

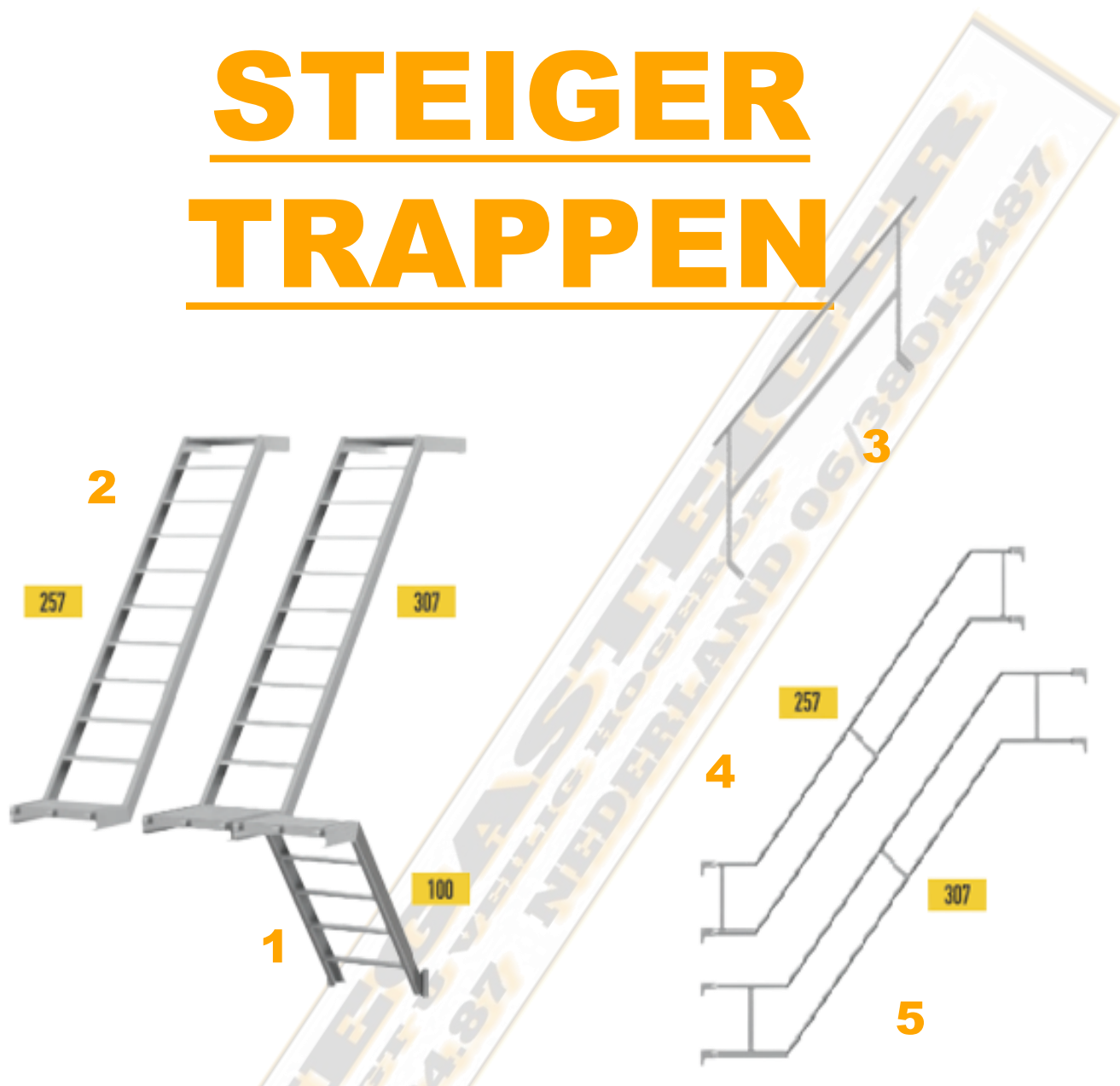

| MODEL | T100 | T257 | T307 | UNI L | L257 | L307 |
|-----------|---------|--------------------|--------------------|-------------------|-------------------|-------------------|
| NR FOTO | 1 | 2 | 2 | 3 | 4 | 5 |
| NAAM | TRAP 1M | TRAP 2M VAK 257 | TRAP 2M VAK 307 | BINNEN LEUNING | BUITEN LEUNING | BUITEN LEUNING |
| GEWICHT | 10,1KG | 19,7KG | 23,5KG | 4,2KG | 5,4KG | 6,2KG |
| VAKLENGTE | UNI | 257 | 307 | UNI | 257 | 307 |
| MATERIAAL | ALU | ALU | ALU | ALU | ALU | ALU |

MUURANKERS

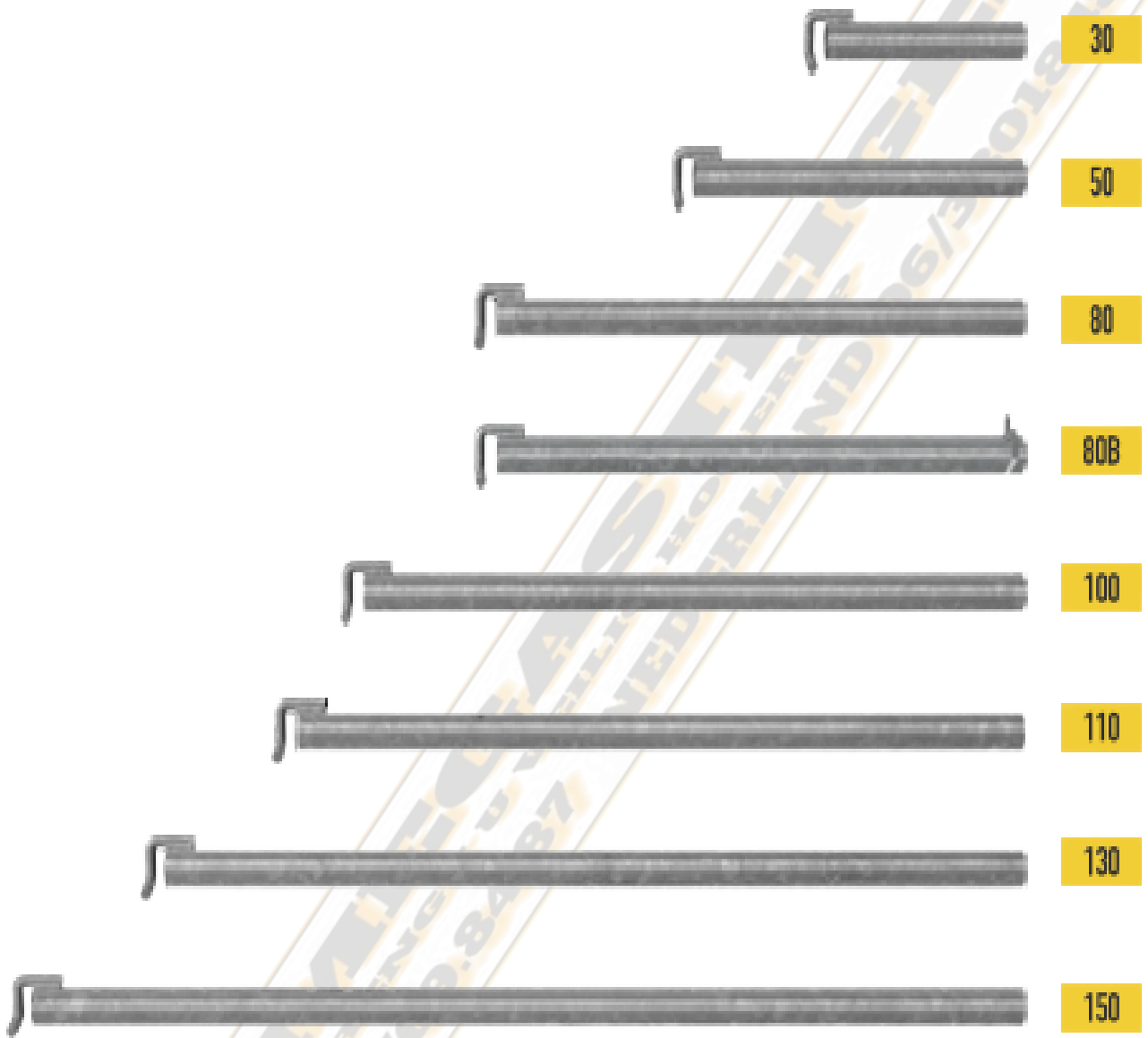

| MODEL | 30 | 50 | 80 | 80B | 100 | 110 | 130 | 150 |
|-----------|-------|-------|-------|-------|-------|-------|-------|-------|
| LENGTE | 300 | 500 | 800 | 800 | 1000 | 1100 | 1300 | 1500 |
| DIAMETER | 48,3 | | | | | | | |
| GEWICHT | 1,3KG | 1,9KG | 2,9KG | 3,1KG | 3,5KG | 3,8KG | 4,6KG | 5,3KG |
| MATERIAAL | GALVA | | | | | | | |

OOGVIJS



**PLUGGEN DIA 14MM
LENGTE 70MM
DOOS 100ST**

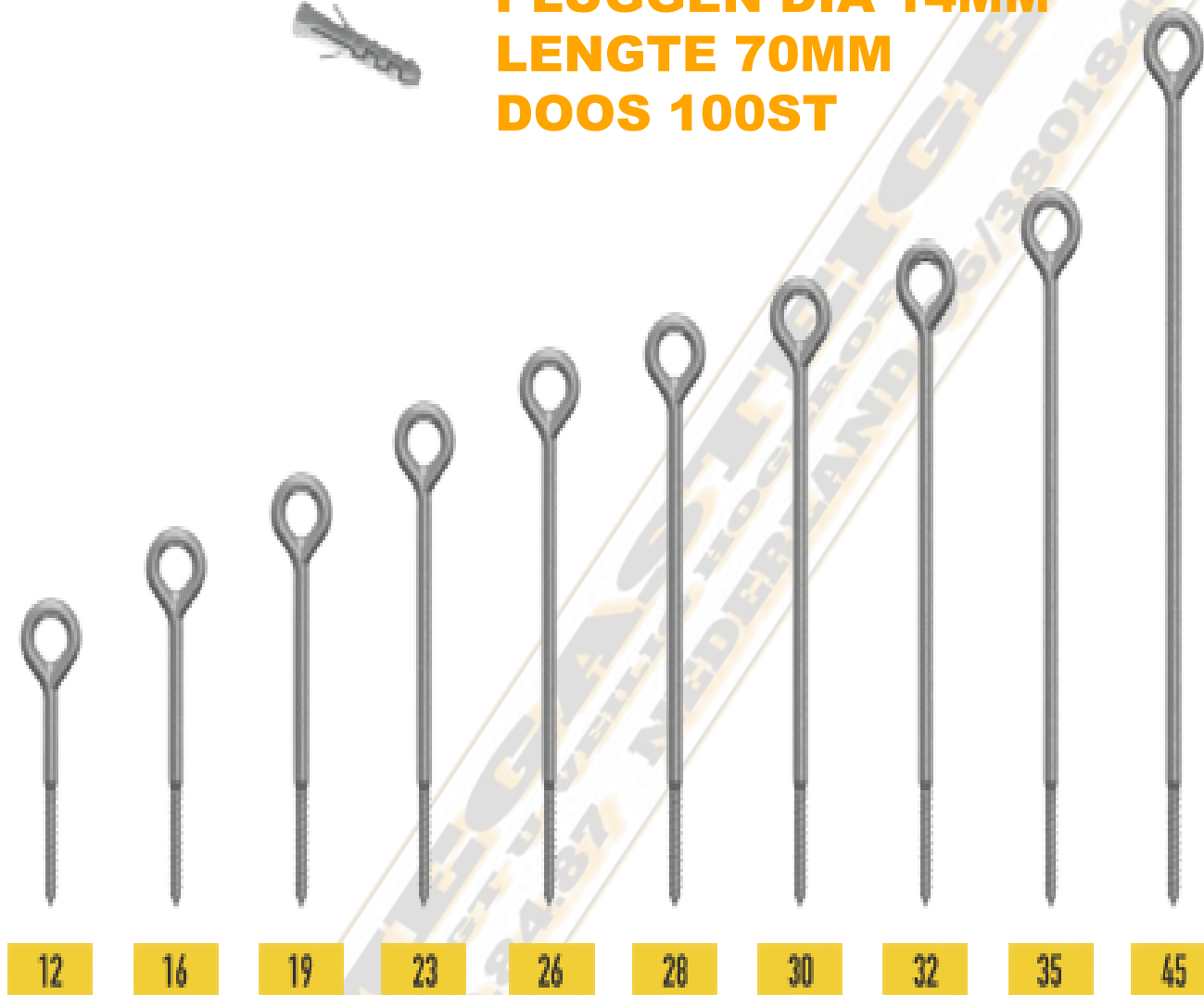

| MODEL | 12 | 16 | 19 | 23 | 26 | 28 | 30 | 32 | 35 | 45 |
|---------|-------|-----|-----|-----|-----|-----|-----|-----|-----|-----|
| LENGTE | 120 | 160 | 190 | 230 | 260 | 280 | 300 | 320 | 350 | 450 |
| DIA | 12MM | | | | | | | | | |
| DIA OOG | 23MM | | | | | | | | | |
| MATERIA | GALVA | | | | | | | | | |

VERVANG ONDERDELEN

**LADDER VOOR
VLONDERS**



LEUNINGHAAK



SLOT VOOR VLONDERLUIK



**SCHARNIEREN VOOR
VLONDERLUIK**



PLATEN

ROBUUSTVLOER

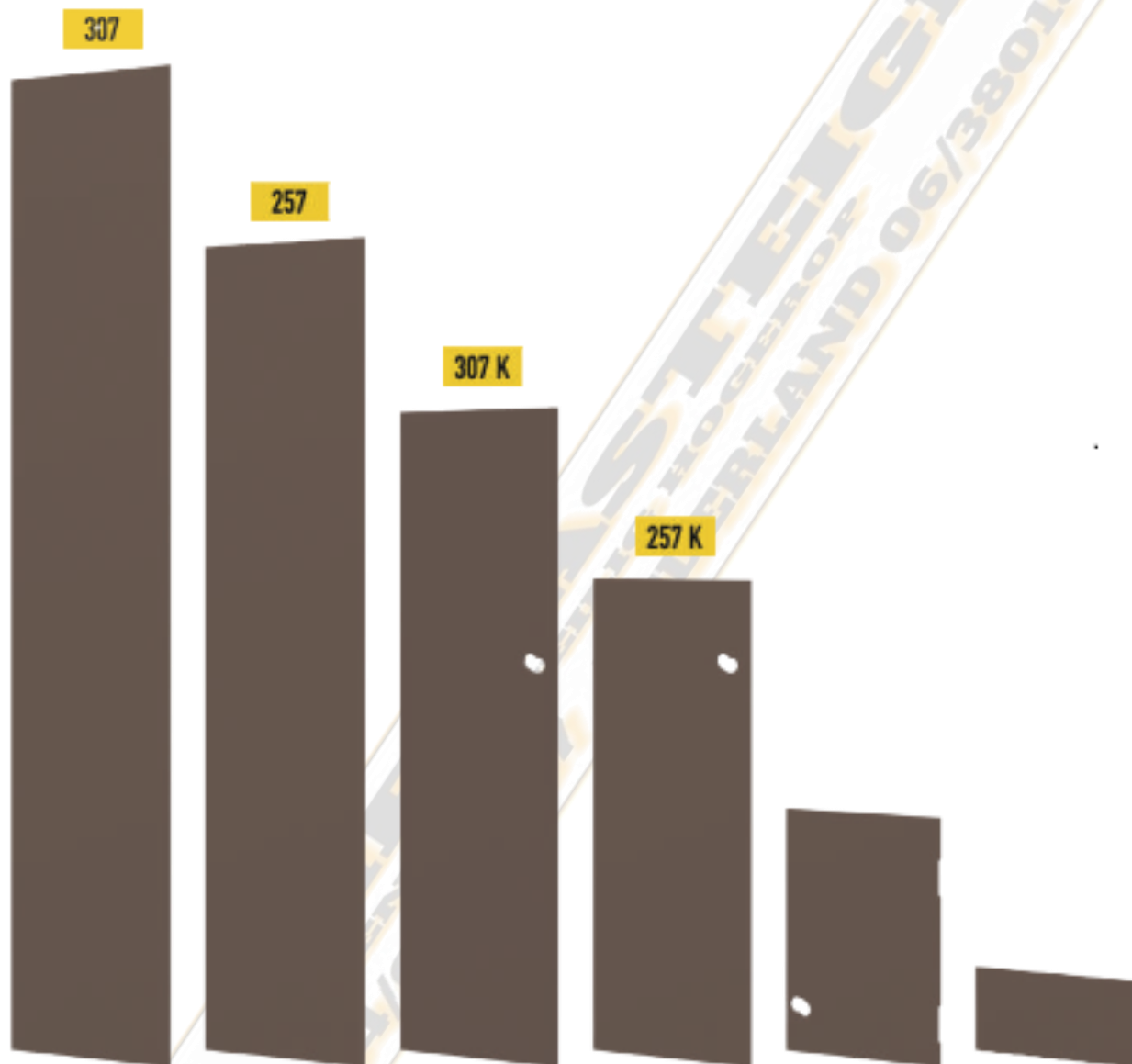

| MODEL | 307 | 257 | 307 K | 257 K | LUIK | KOP |
|---------|---------------|---------------|--------------|---------------|------|---------|
| DIKTE | 10MM | | | | | |
| BREEDTE | 55MM | | | | | |
| LENGTE | 2994 | 2494 | 1941 | 1441 | 829 | 204 |
| TYPE | ROBUUST VLOER | ROBUUST VLOER | LDDER OPGANG | LADDER OPGANG | LUIK | KOPSTUK |

STAPELPALET



PALM1

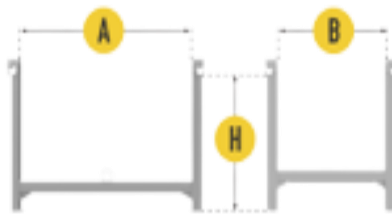

PALR1



PALS1

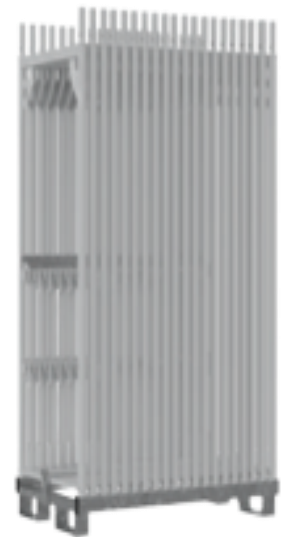
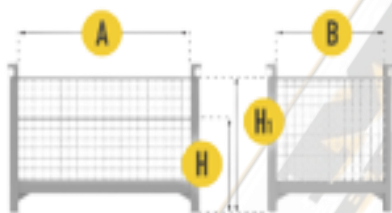

| MODEL | PALM1 | PALS1 | PALR1 |
|-------------|--------|--------|--------|
| LENGTE (A) | 1080 | 1080 | 1220 |
| BREEDTE (B) | 680 | 680 | 770 |
| HOOGTE (C) | 760 | 760 | 320 |
| GEWICHT | 43,8KG | 70,9KG | 34,7KG |

NOTITIES

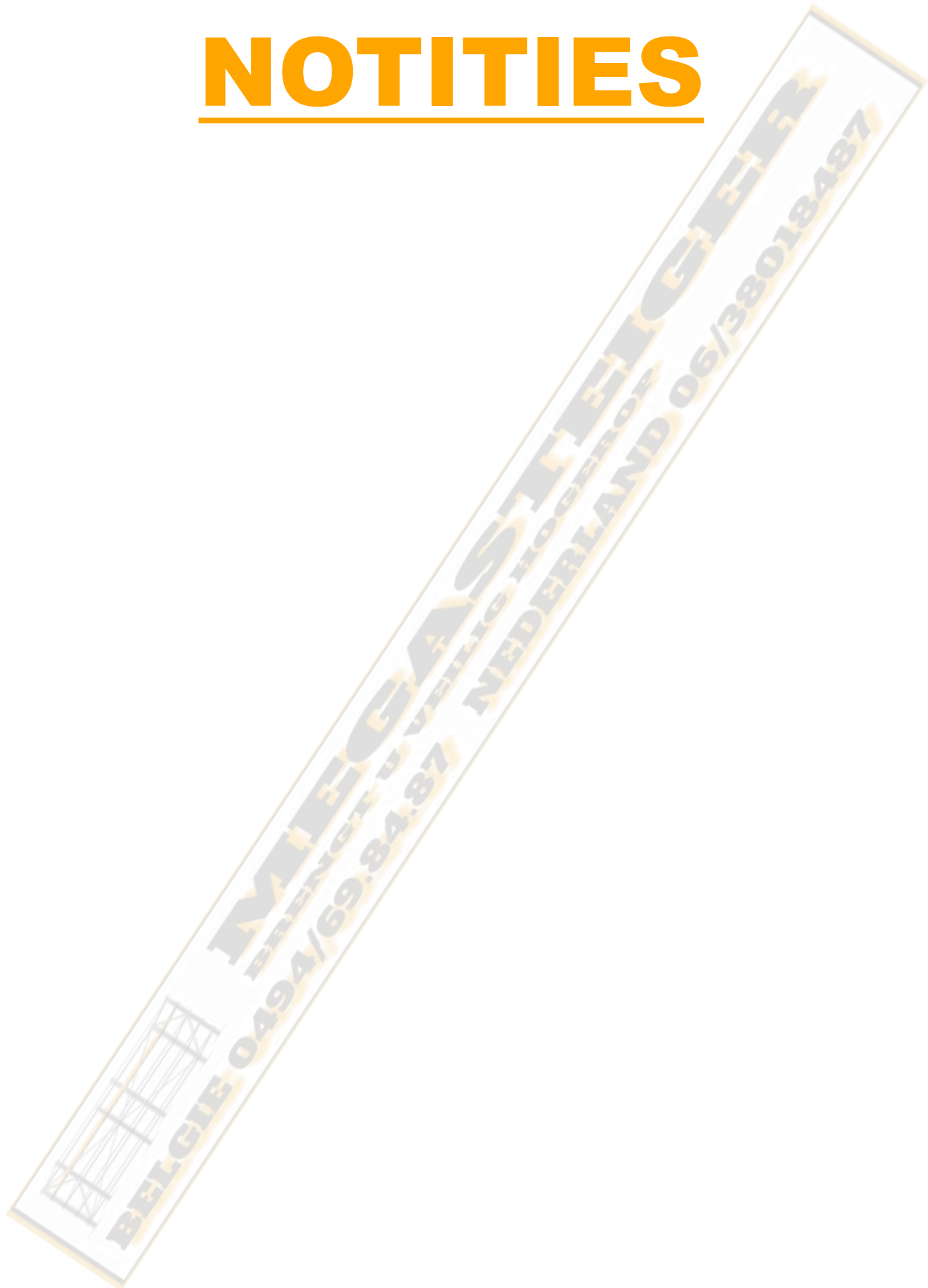

NOTITIES

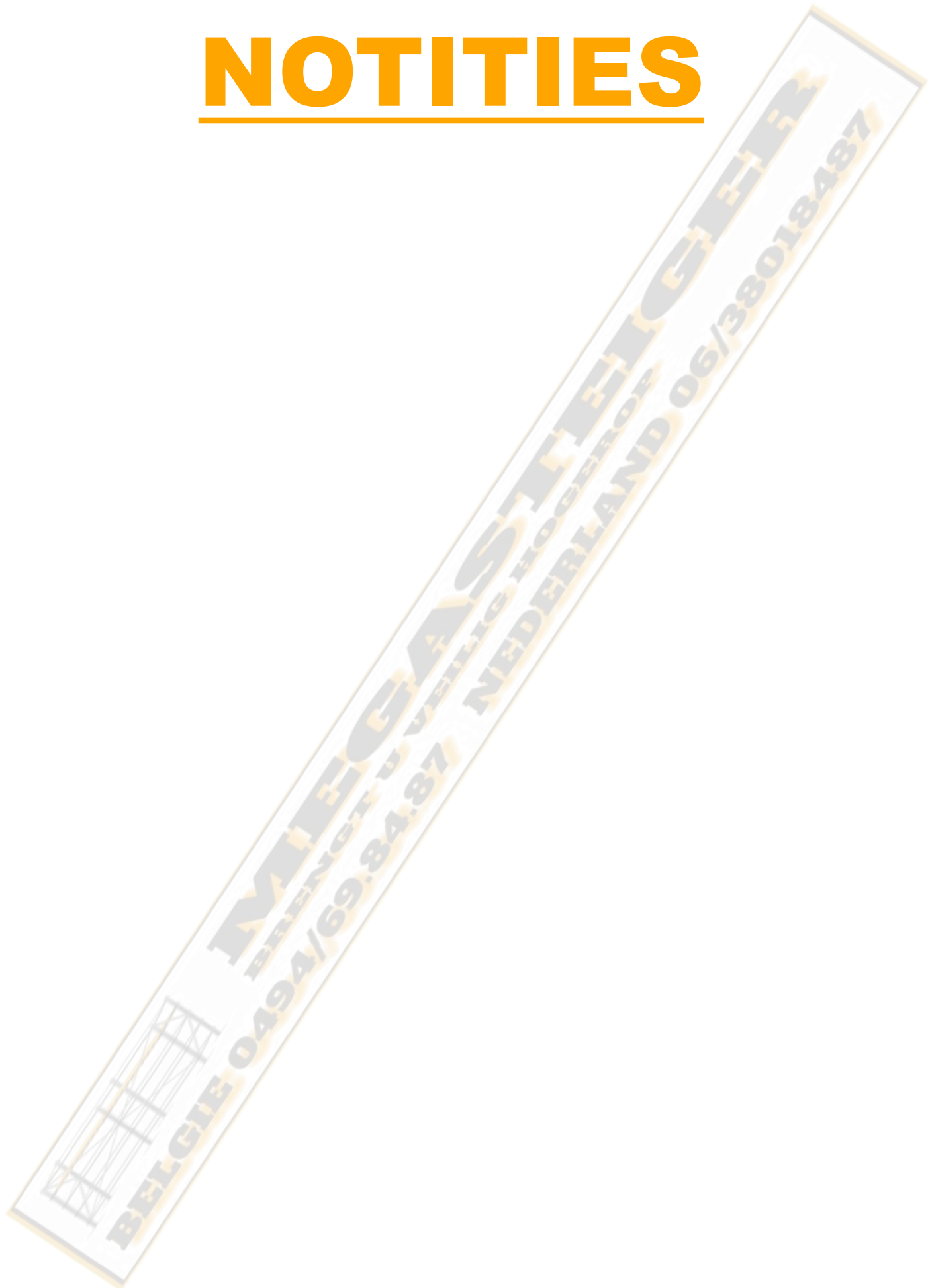

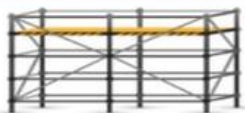

MEGASTEIGER

BRENGT U VEILIG HOGEROP

BELGIE 0494/69.84.87 NEDERLAND 06/38018487

Uw handelaar in nieuwe STEIGERS en STELLINGEN

**Maar ook uw specialist in
GEBRUIKTE steigers van alle merken
zoals LAYHER Blitz en allround ,
ALTRAD SL70 en Assco , MJ ,
SCAFOM RUX en alle compatibele
merken**

**Al onze steigers
zijn GECERTIFICEERD en voorzien
van alle keuringen**

**Ze voldoen aan alle wettelijke
vereisten**

**Onze stellingen komen allemaal
vanuit hoogstaande Europese
productie**

CONTACTEER ONS

BELGIE 0494/69.84.87. => BELLEN - SMSSEN - WHATSAPP
NEDERLAND 06/380.18.487. => BELLEN - SMSSEN - WHATSAPP

MEGASTEIGER
Stationspark 8A , 4462 DZ Goes